



FIMAC

LIFT TO THE FUTURE



*"DOVE IL TUO MONDO INCONTRA LA QUOTIDIANITÀ,
SI CREA UNO SPAZIO UNICO ED ESCLUSIVO.
PROGETTIAMO ESPERIENZE DI PARCHEGGIO
PER ACCOGLIERTI A CASA E FARTI VIVERE AL MASSIMO
QUESTO MOMENTO SPECIALE."*



Azienda

Sicurezza e affidabilità per le vostre esigenze di parcheggio e movimentazione merci

Il viaggio di **Fimac Lift** è iniziato oltre 30 anni fa dalla passione e dalla competenza di Cristian Poltronieri nel settore dei sistemi semiautomatici di parcheggio. Esperienza e determinazione condivise con la moglie Fiorella e tramandate ai figli Matteo e Andrea, che rendono **Fimac Lift** oggi un punto di riferimento sul mercato, sia in Italia che all'estero.

La nostra azienda poggia solide radici nella tradizione manifatturiera, ma pone lo sguardo costantemente al futuro, alla continua ricerca delle tecnologie e delle tecniche di progettazione più efficaci.

Fimac Lift offre una gamma completa di soluzioni semiautomatiche di parcheggio.

Dagli ascensori per auto, pensati per garantire un accesso facile e sicuro ai garage, ai parcheggi meccanizzati, progettati per ottimizzare gli spazi, fino ai montacarichi industriali.

Una vasta linea di prodotti personalizzabili, per rispondere a qualsiasi necessità. Non solo progettazione e installazione degli impianti. La piena soddisfazione dei nostri clienti è ciò che quotidianamente ci guida.

Per questo, offriamo un servizio di assistenza e manutenzione tempestivo ed efficace, che ci consente di rispondere rapidamente e in modo mirato ad ogni esigenza.

Le soluzioni Fimac Lift sono conformi ai più elevati standard europei di riferimento:



Direttiva macchine
2006/42/CE

Compatibilità elettromagnetica
2014/30/UE

Apparecchiature in bassa tensione
2014/35/UE





1 Ascensori per auto

Lift X1
Ascensore per auto a **pantografo**
Pag. 8

Lift H4
Ascensore per auto a **colonne**
Pag. 12

Lift X1 T
Ascensore per auto a **pantografo** con **tetto di copertura**
Pag. 16

Lift H4 T
Ascensore per auto a **colonne** con **tetto di copertura**
Pag. 20

Lift X1 girevole
Ascensore per auto **girevole** a **pantografo**
Pag. 24

Lift H4 girevole
Ascensore per auto **girevole** a **colonne**
Pag. 26

Lift X1 T girevole
Ascensore per auto **girevole** a **pantografo** con **tetto di copertura**
Pag. 28



2 Parcheggi meccanizzati

Box H4-T1
Parcheggio **singolo verticale** a scomparsa con sistema a **colonna**
Pag. 32

Box H4-T2
Parcheggio **doppio verticale** a scomparsa con sistema a **colonna**
Pag. 34

Box H4-T4
Parcheggio **doppio orizzontale** con sistema a **colonna**
Pag. 36

Box H2-H4
Parcheggio **multiplo** per auto a posti indipendenti con sistema a **colonna**
Pag. 38



3 Montacarichi

Work H1
Montacarichi a **singola colonna**
Pag. 42

Work H2
Montacarichi a **doppia colonna**
Pag. 43

Work H2 T
Montacarichi a **doppia colonna** con **tetto di copertura**
Pag. 44

Work H4
Montacarichi a **quattro colonne**
Pag. 45

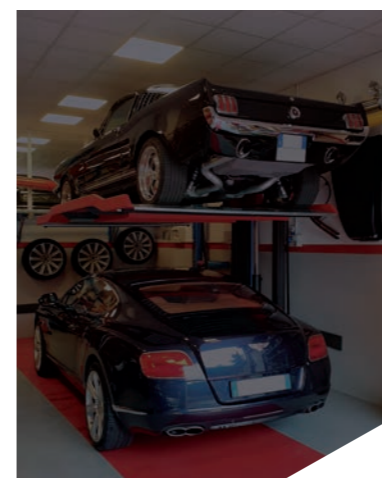

4 Elevatori per box

B-Box
Raddoppiatore posto auto con sistema a **colonna**
Pag. 48

H-Box
Raddoppiatore posto auto con sistema a **doppia colonna**
Pag. 50

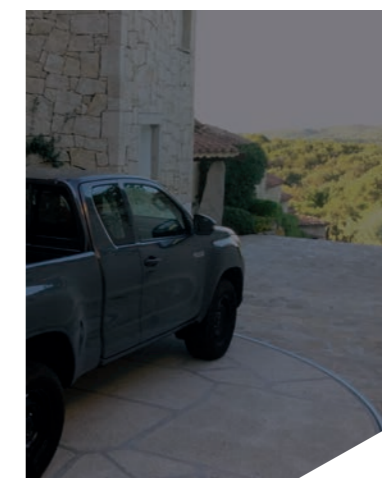

5 Piattaforme

Rotante
Facilità di **manovra** e ottimizzazione degli spazi limitati
Pag. 54

A trazione
Facilità di **parcheggio** in spazi minimi
Pag. 55

Traslante
Più posti auto grazie allo **spostamento laterale**
Pag. 55



6 Accessori di chiusura e protezione

Cancelli a scomparsa
Pag. 58

Porte sezionali
Pag. 60

Serrande avvolgibili e tapparelle
Pag. 61

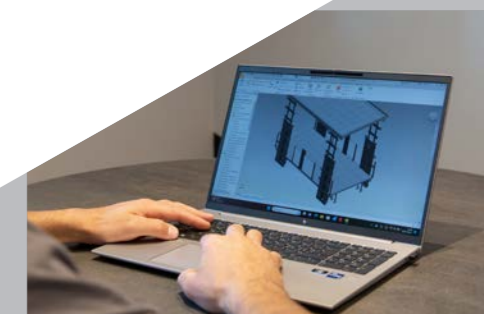

Servizi
Pag. 62

1

Ascensori per auto



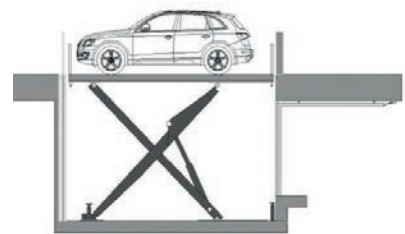

Lift X1

Ascensore per auto a **pantografo** con o senza conducente a bordo

Portata piattaforma 3500 kg (875 kg ogni ruota) o personalizzata.



Sistema
Pantografo



Corsa massima
3800 mm



Portata
3500 kg



Motore
Volt 380
(220 con inverter)



Fossa minima
650/550 mm



Conformità
2006/42/CE
2014/30/UE
2014/35/UE

Le misure e portate possono essere modificate in base all'esigenza del cliente.

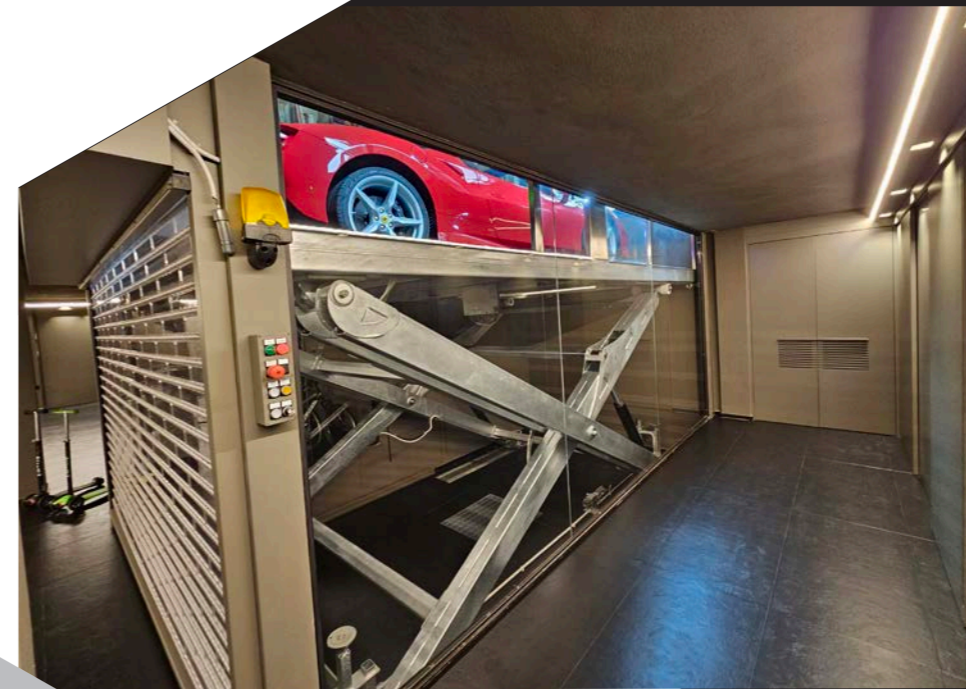

DESIGN MINIMALE
ED ELEGANTE PER
UNA SOLUZIONE DI
PARCHEGGIO SICURA
E VERSATILE.

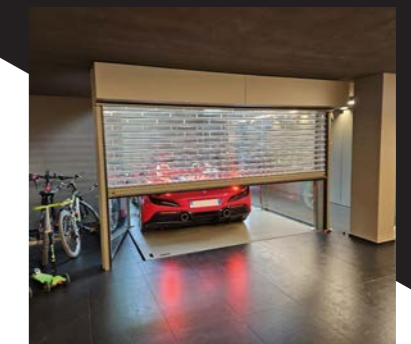
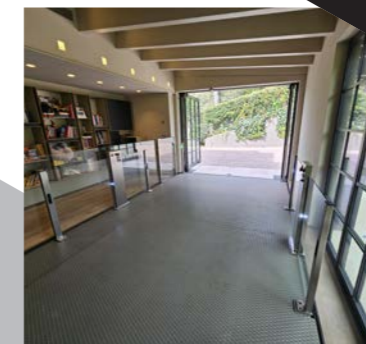

Lift X1

PERSONALIZZAZIONI E ACCESSORI



Pianale grigliato



Cancello verticale varie progettazioni



Senza conducente a bordo



Modelli vari per chiusure piano interrato



Finiture personalizzate



Impianto zincato e verniciato RAL a scelta



SPECIFICHE TECNICHE

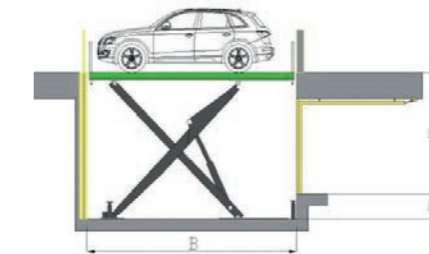
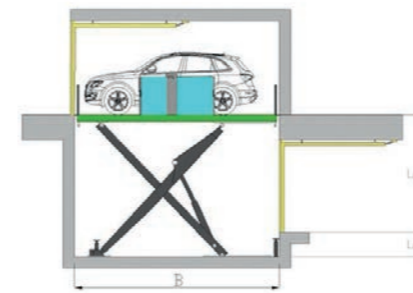

Versione con sezionale o cancello a scomparsa

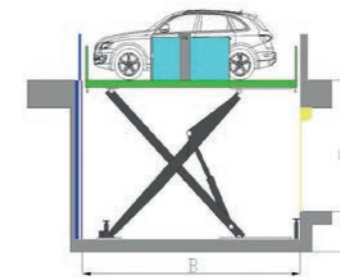
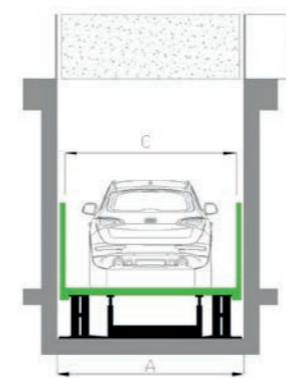

Versione con cancello a scomparsa e avvolgibile

Dimensioni consigliate

- A Larghezza fossa: 2900 mm
 - B Lunghezza fossa: 5600 mm + 220 mm cancello a scomparsa
 - C Larghezza utile per autovettura: 2700 mm con conducente a bordo
Larghezza senza conducente a bordo: 2800 mm
 - D Lunghezza utile per autovettura con fotocellule di centraggio: 5400 mm
 - E Corsa massima: 3800 mm (limitata in base alla lunghezza della fossa)
 - F Altezza fossa: 650/550 mm
 - G Altezza parapetto piano terra: 1100 mm
- Portata piattaforma: 3500 kg
Motore: Kw 4 / 5,5 / Volt 380 / 220 con inverter



Le misure e portate possono essere modificate in base all'esigenza del cliente

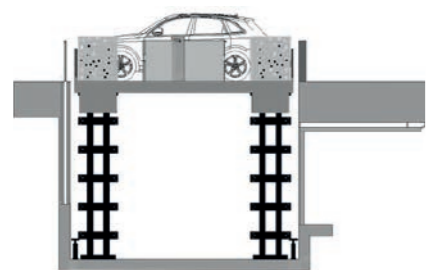

Lift H4

Ascensore per auto a **colonne**
con o senza conducente a bordo

Portata piattaforma 3500 kg (875 kg ogni ruota)
o personalizzata.



Sistema
Colonna



Corsa
Da 0 a 12000
mm



Portata
3500 kg



Motore
Volt 380
(220 con
inverter)



**Fossa
minima**
300 mm



Conformità
2006/42/CE
2014/30/UE
2014/35/UE

Le misure e portate possono essere modificate in base all'esigenza del cliente.

FINITURE E COLORI
PERSONALIZZABILI
PER INTEGRARSI
PERFETTAMENTE
CON L'AMBIENTE
CIRCOSTANTE.

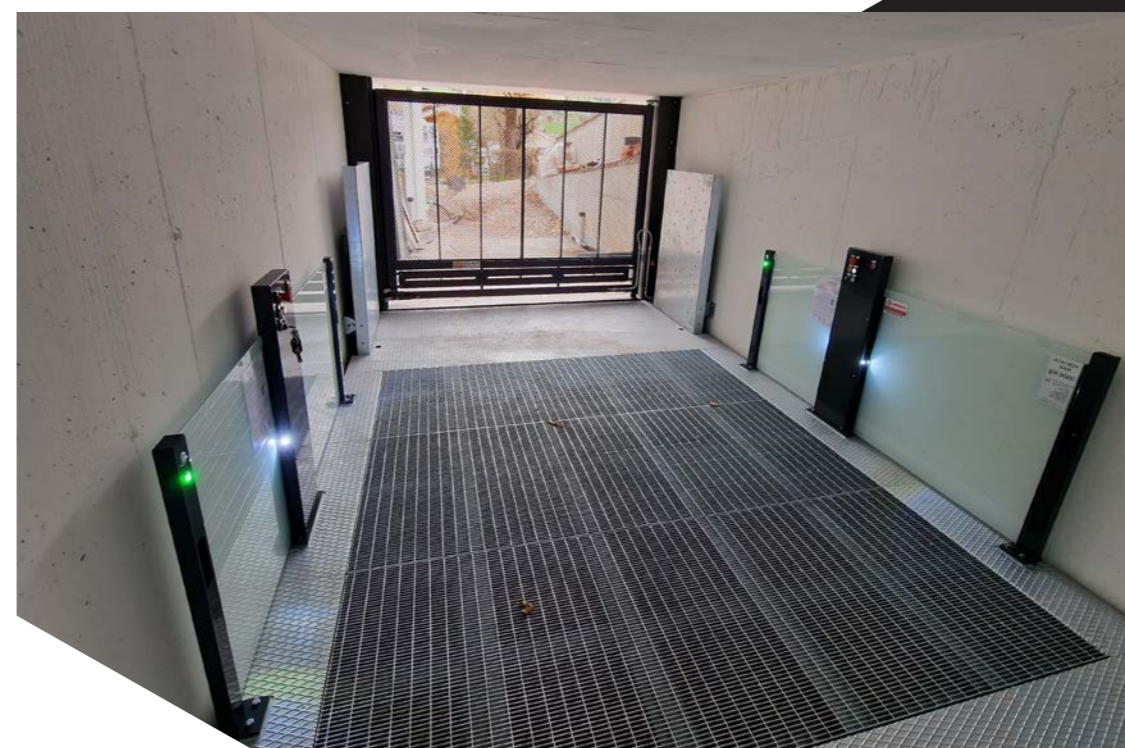

Lift H4

REALIZZAZIONI



SPECIFICHE TECNICHE

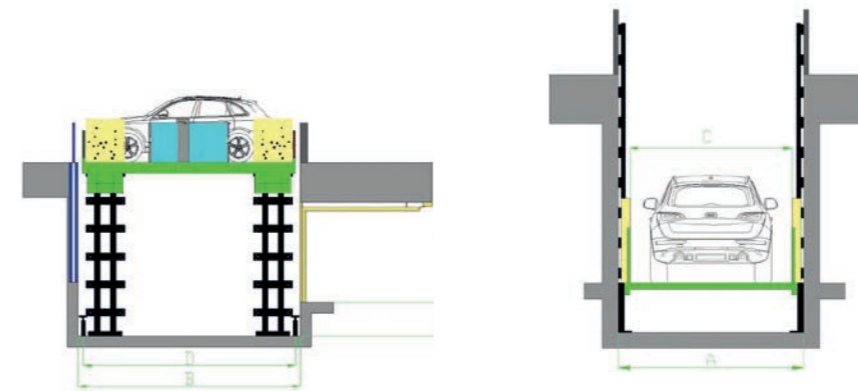

Dimensioni consigliate

- A Larghezza fossa: 3200 mm
 - B Lunghezza fossa: 5600 mm + 220 mm eventuale cancello a scomparsa
 - C Larghezza piattaforma utile per autovettura: 2800 mm
 - D Lunghezza utile per autovettura con barriere di centraggio: 5400 mm
 - E Corsa: da 0 a 12000 mm
 - F Altezza fossa minima: 300 mm
- Portata piattaforma: kg 3500
 Motore: Kw 4/5/7,5 / Volt 380 / 220 con inverter (in base alla portata)

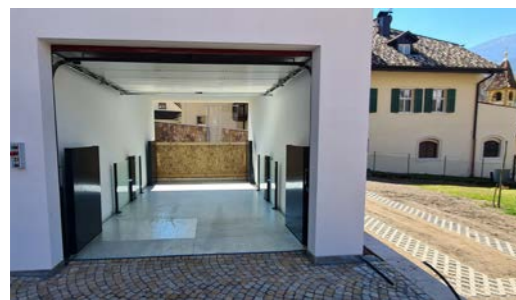

Le misure e portate possono essere modificate in base all'esigenza del cliente

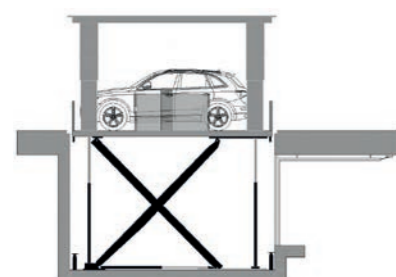
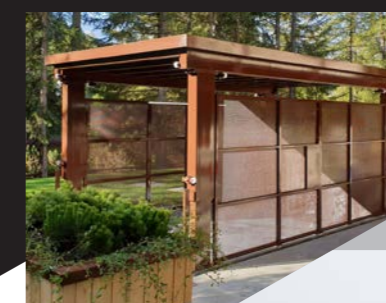
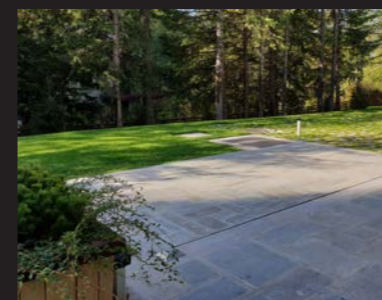

Lift X1 T

Ascensore per auto a **pantografo** con **tetto** di copertura con o senza conducente a bordo

Portata piattaforma 3500 kg più tetto di copertura
pavimentabile 150 kg mq



Sistema
Pantografo



Corsa massima
3500 mm



Portata
3500 kg
+ tetto
150 kg mq



Motore
Volt 380
(220 con
inverter)

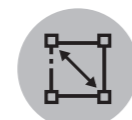

Fossa minima
550 mm



Conformità
2006/42/CE
2014/30/UE
2014/35/UE

Le misure e portate possono essere modificate in base all'esigenza del cliente.

*SISTEMA DI
PARCHEGGIO SOLIDO
E AFFIDABILE,
PERSONALIZZABILE
NEI MINIMI DETTAGLI,
DAL TETTO DI
COPERTURA AI
MATERIALI.*

Lift X1 T

PERSONALIZZAZIONI E ACCESSORI



Versione certificata senza parapetti superiori: reti di protezione a bordo, pavimentabile



Piano interrato



Videosorveglianza a bordo piattaforma



Fotocellule carrabili

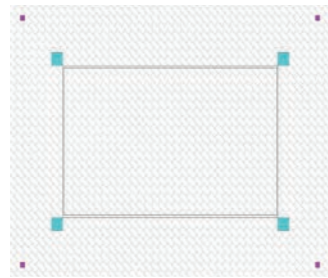

Perimetro fotocellule di sicurezza



Versione certificata con protezioni superiori



SPECIFICHE TECNICHE

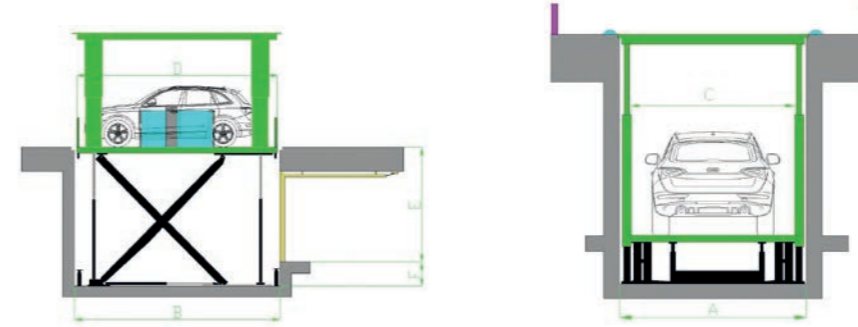

Dimensioni consigliate

- A Larghezza fossa: 3000 mm
 - B Lunghezza fossa: 5500 mm
 - C Larghezza utile per autovettura: 2600 mm
 - D Lunghezza utile per autovettura con barriere di centraggio: 5300 mm
 - E Corsa massima: 3500 mm
 - F Altezza fossa: 550 mm
- Portata piattaforma: 3500 kg più tetto di copertura pavimentabile 150 kg mq
Motore: Kw 5,5 / 7,5 / Volt 380 / 220 con inverter



Le misure e portate possono essere modificate in base all'esigenza del cliente

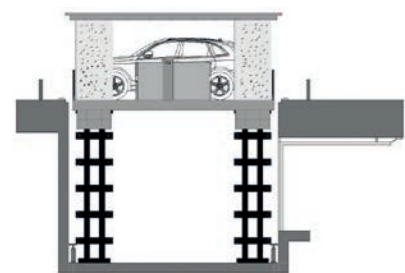

Lift H4 T

Ascensore per auto a **colonne** con **tetto** di copertura con o senza conducente a bordo

Portata piattaforma 3500 kg più tetto 150 kg mq.
Conducente a bordo corredato di fotocellule perimetrali piano terra e videosorveglianza.



Sistema
Colonna



Corsa
Da 0 a 12000
mm



Portata
3500 kg
+ tetto
150 kg mq



Motore
Volt 380
(220 con
inverter)



**Fossa
minima**
800 mm



Conformità
2006/42/CE
2014/30/UE
2014/35/UE

Le misure e portate possono essere modificate in base all'esigenza del cliente.



SOLUZIONE
APPOSITAMENTE
PROGETTATA
PER OTTENERE IL
MASSIMO IN SPAZI
RISTRETTI E IN CASO
DI INSTALLAZIONI
ESTERNE.



Lift H4 T

PERSONALIZZAZIONI E ACCESSORI



Versione certificata senza parapetti superiori



Piano interrato



Videosorveglianza a bordo piattaforma



Fotocellule carrabili

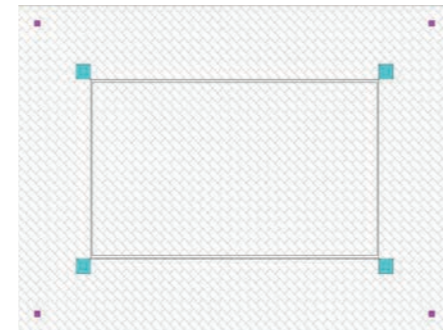

Perimetro fotocellule di sicurezza



Versione certificata con protezioni superiori



SPECIFICHE TECNICHE

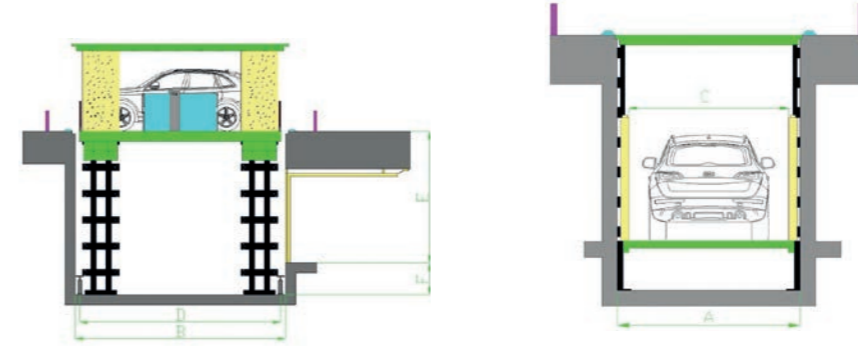

Dimensioni consigliate

- A Larghezza fossa: 3300 mm
 - B Lunghezza fossa: 5500 mm
 - C Larghezza piattaforma utile per autovettura: 2900 mm
 - D Lunghezza utile per autovettura con barriere di centraggio: 5300 mm
 - E Corsa: da 0 a 12000 mm
 - F Altezza fossa: 800 mm
- Portata piattaforma: kg 3500 più tetto di copertura pavimentabile 150 kg mq
Motore: Kw 5,5 / 7,5 / Volt 380 / 220 con inverter

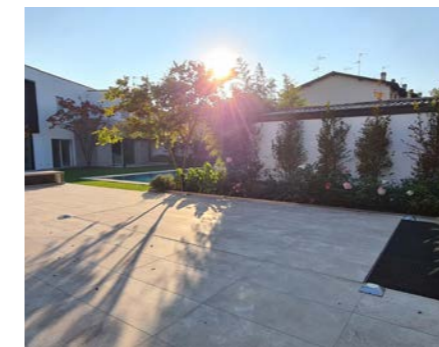
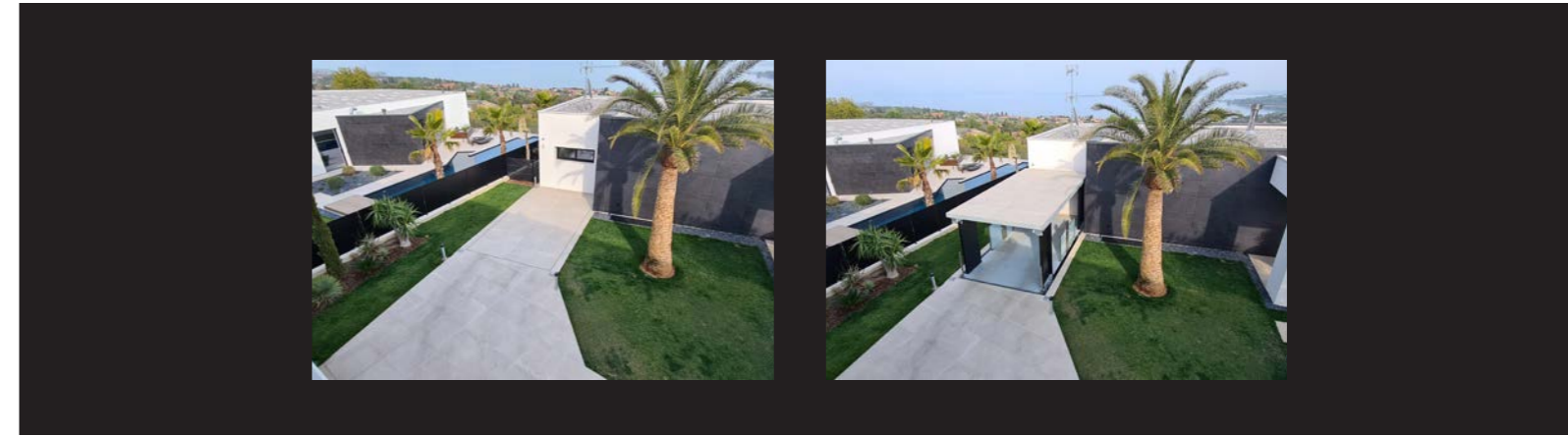

Le misure e portate possono essere modificate in base all'esigenza del cliente

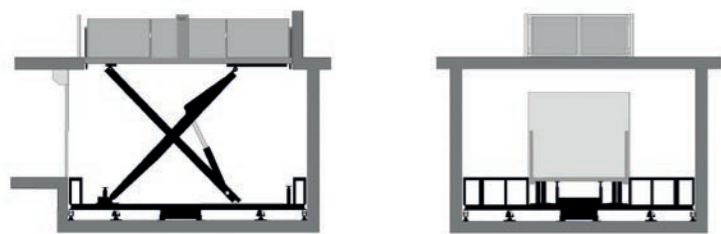

Lift X1 girevole

Ascensore per auto **girevole a pantografo** con o senza conducente a bordo

Portata piattaforma 3000 kg (750 kg ogni ruota) o personalizzata.



Sistema
Pantografo



Corsa massima
3500 mm



Portata
3000 kg



Motore
Kw 4
Volt 380
(220 con inverter)



Conformità
2006/42/CE
2014/30/UE
2014/35/UE

Dimensioni consigliate
Diametro fossa: 6400 mm
Larghezza fossa: 2900 mm
Lunghezza fossa: 5500 mm
Larghezza piattaforma utile: 2700 mm
Lunghezza utile con fotocellule di centraggio autovettura: 5300 mm
Corsa massima: 3800 mm (limitata in base alla lunghezza della fossa)
Ingombro piattaforma: 1200 mm

Le misure e portate possono essere modificate in base all'esigenza del cliente.

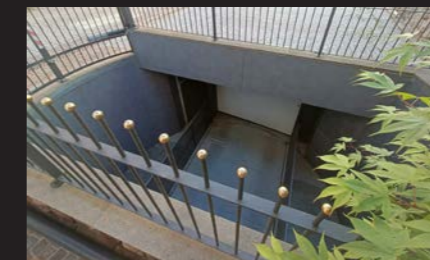
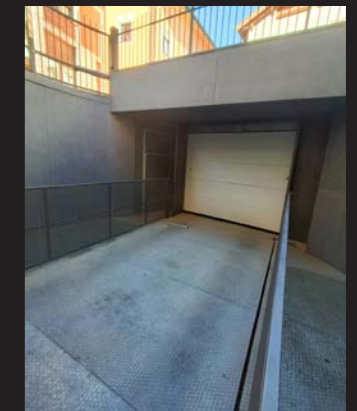

IDEALE PER ACCEDERE FACILMENTE ED IN SICUREZZA ALLE AUTORIMESSE CON ACCESSO NON IN LINEA AL SOLLEVATORE.



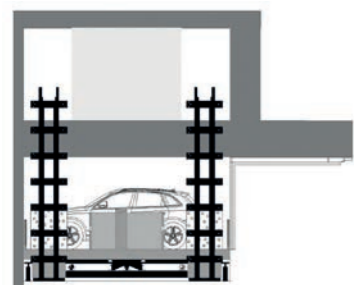

Lift H4 girevole

Ascensore per auto **girevole a colonne** con o senza conducente a bordo

Portata piattaforma 3500 kg (875 kg ogni ruota) o personalizzata.



Sistema
Colonna



Corsa
Da 0 a 12000 mm



Portata
3500 kg



Motore
Kw 7,5
Volt 380



Conformità
2006/42/CE
2014/30/UE
2014/35/UE

Dimensioni consigliate
Larghezza fossa: 6500 mm
Lunghezza fossa: 6500 mm
Larghezza piattaforma utile: 2650 mm
Lunghezza utile con barriere di centraggio autovettura: 5600 mm
Corsa: da 0 a 12000 mm
Altezza fossa: 1200 mm

Le misure e portate possono essere modificate in base all'esigenza del cliente.

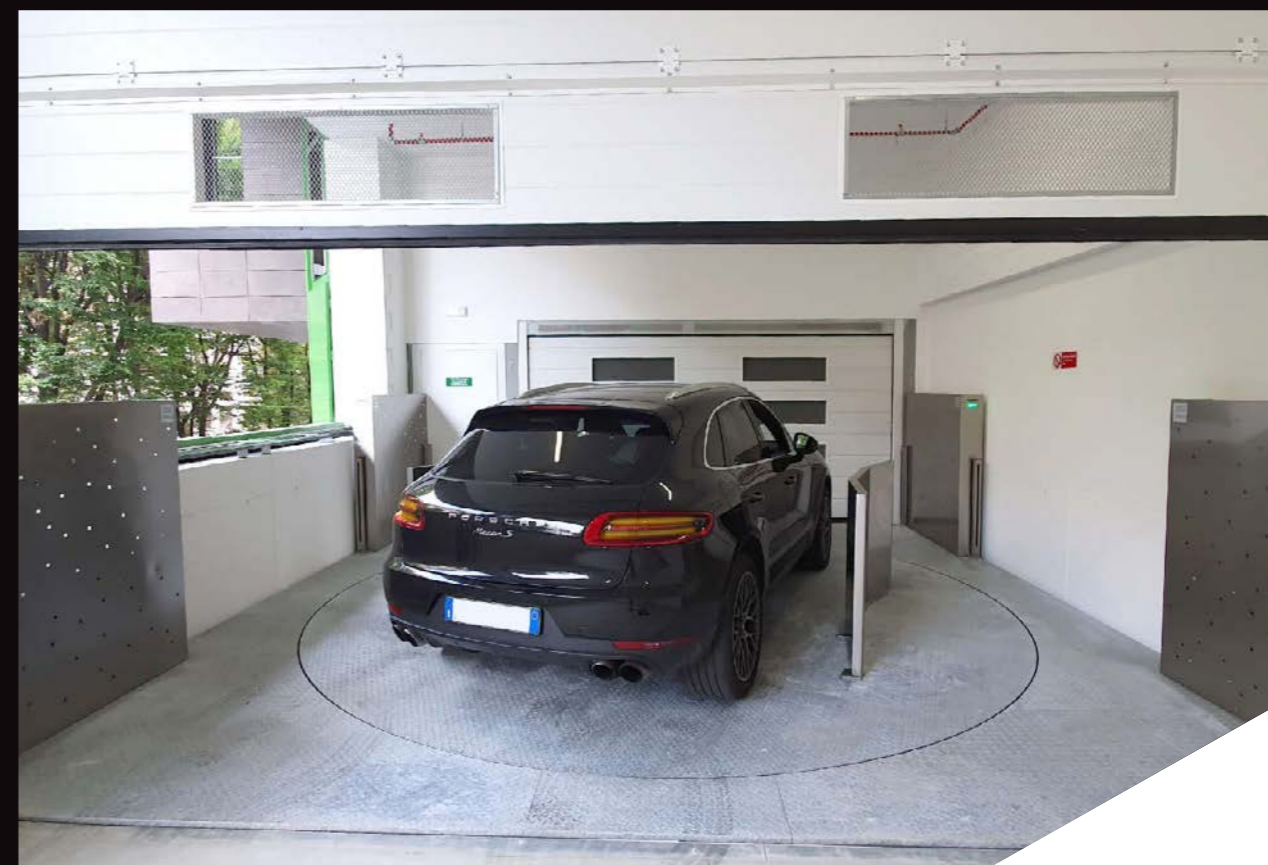

LA SINTESI PERFETTA TRA INGEGNERIA, ARCHITETTURA E DESIGN, CON LA POSSIBILITÀ DI RUOTARE SU OGNI PIANO DI SBARCO PRESENTE.

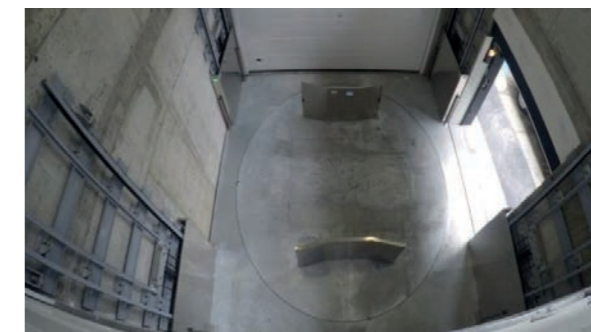

INNOVAZIONE E
PROTEZIONE PER LE
VOSTRE SOLUZIONI
DI PARCHEGGIO,
REALIZZABILI
COMPLETAMENTE SU
MISURA.

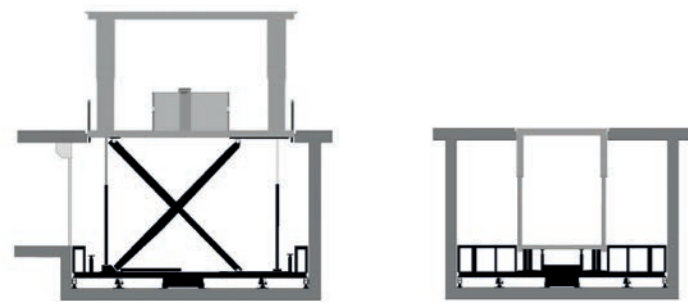
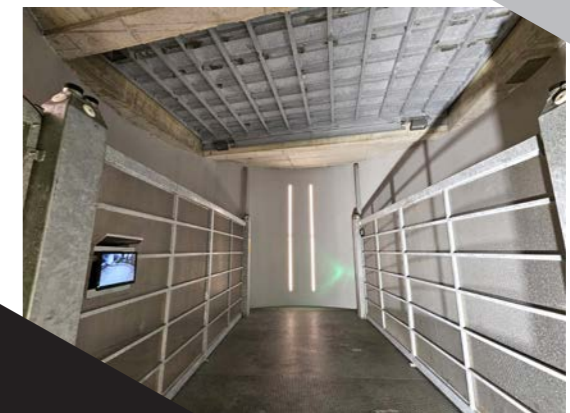

Lift X1 T girevole

Ascensore per auto **girevole a pantografo** con **tetto** di copertura con o senza conducente a bordo

Portata piattaforma 5000 kg o personalizzata.



Sistema
Pantografo



Corsa massima
3500 mm



Portata
3500 kg
+ pavimentazione
150 kg mq



Motore
Kw 5,5
Volt 380
(220 con
inverter)



Conformità
2006/42/CE
2014/30/UE
2014/35/UE

Dimensioni consigliate

Diametro fossa: 6400 mm
Larghezza fossa: 2900 mm
Lunghezza fossa: 5500 mm
Larghezza piattaforma utile: 2500 mm
Lunghezza utile con fotocellule di centraggio autovettura: 5300 mm
Corsa massima: 3500 mm (limitata in base alla lunghezza della fossa)
Ingombro piattaforma: 1100 mm

Le misure e portate possono essere modificate in base all'esigenza del cliente.

2

Parcheeggi meccanizzati



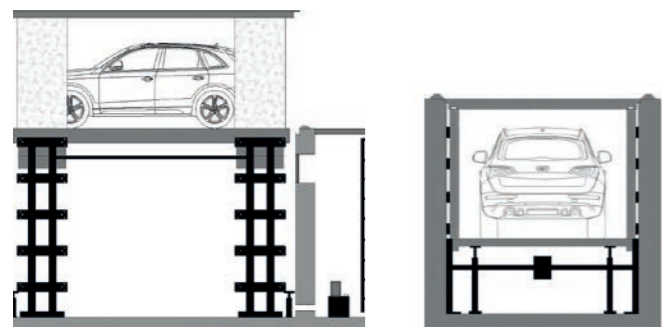

Box H4-T1

Parccheggio **singolo** a scomparsa con sistema **a colonna**

Parccheggio meccanizzato per auto ad uso garage



Sistema
Colonna



Portata
3500 kg + tetto
150 kg mq



Motore
Kw 5,5
Volt 380
(220 con inverter)

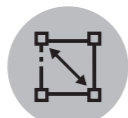

Altezza totale
2700 mm
con interpiano
da 2000 mm



Conformità
2006/42/CE
2014/30/UE
2014/35/UE

Dimensioni consigliate

Larghezza fossa: 3200 mm
Lunghezza fossa: 5500 mm
Larghezza piattaforma utile: 2800 mm
Lunghezza utile con barriere di centraggio autovettura: 5300 mm
Corsa: 2150 mm (variabile In base all'interpiano e pavimentazione)
Utile interpiano: 2000 mm

Le misure e portate possono essere modificate in base all'esigenza del cliente.



L'IMPIANTO IDEALE PER LE AREE PARTICOLARMENTE STRETTE, COME CENTRI STORICI, CORTILI E CONDOMINI.

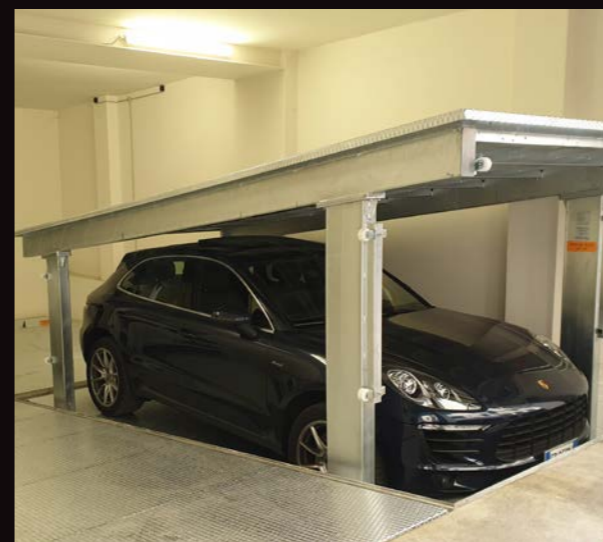

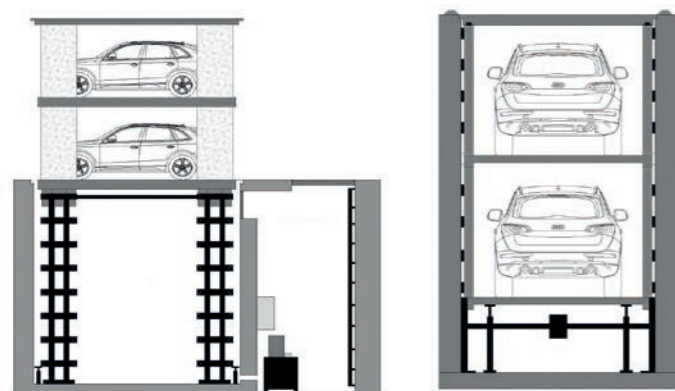

Box H4-T2

Parccheggio doppio verticale a scomparsa con sistema a colonna

Parccheggio meccanizzato per due auto ad uso garage



Sistema
Colonna



Portata
2500 kg per piano + tetto
150 kg mq



Motore
Kw 7,5/9
Volt 380
(220 con inverter)

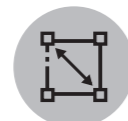

Altezza totale
5400 mm
con interpiano da 2000 mm



Conformità
2006/42/CE
2014/30/UE
2014/35/UE

Dimensioni consigliate
Larghezza fossa: 3300 mm
Lunghezza fossa: 5500 mm
Larghezza piattaforma utile: 2900 mm
Lunghezza utile con barriere di centraggio autovettura: 5300 mm
Corsa: 4400 mm (variabile in base all'interpiano e pavimentazione)
Utile interpiano: 2000 mm
Altezza fossa: 5400 mm (variabile)

Le misure e portate possono essere modificate in base all'esigenza del cliente.

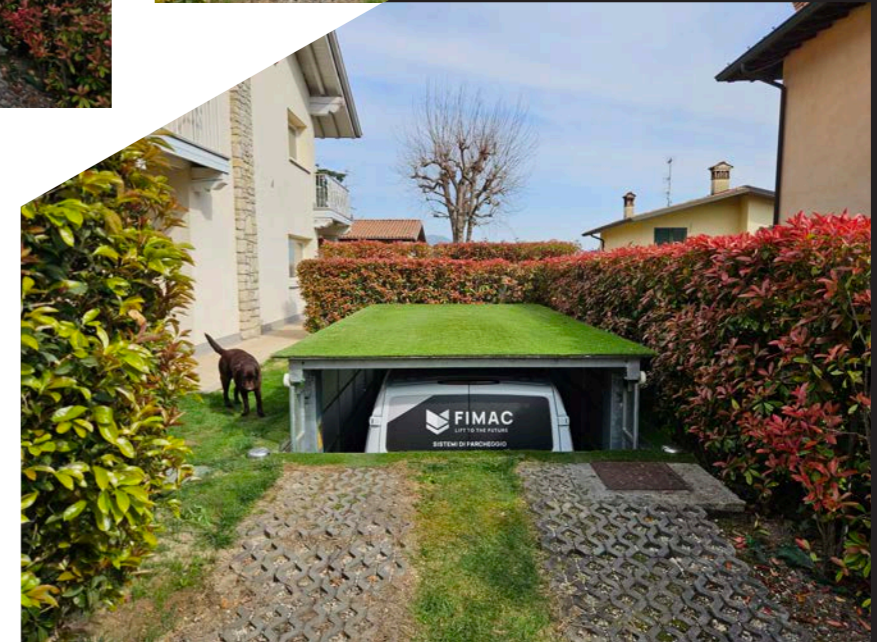

SEMPLICITÀ DI
UTILIZZO, SICUREZZA
ED ELEGANZA, PER
AMPLIARE LE VOSTRE
POSSIBILITÀ DI
PARCHEGGIO.



TECNOLOGIA ED ESTETICA AL SERVIZIO DELL'AMBIENTE, PER RIORGANIZZARE IN MODO ELEGANTE I VOSTRI SPAZI.

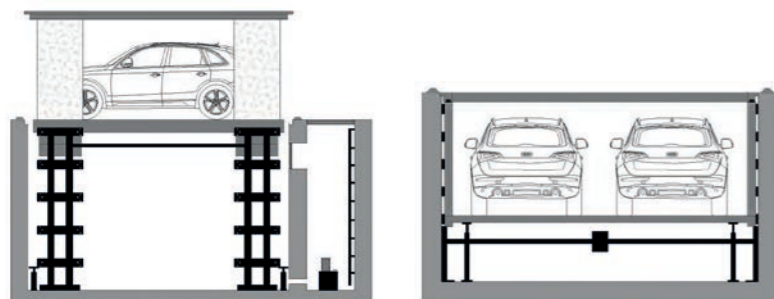

Box H4-T4

Parcheggio doppio orizzontale a scomparsa con sistema a colonna

Parcheggio meccanizzato per due auto ad uso garage



Sistema
Colonna



Portata
2500 kg posto auto + tetto
150 kg mq



Motore
Kw 5,5/7,5
Volt 380



Altezza fossa totale
3300 mm
con interpiano da 2000 mm



Conformità
2006/42/CE
2014/30/UE
2014/35/UE

Dimensioni consigliate
Larghezza fossa: 5500 mm
Lunghezza fossa: 5500 mm
Larghezza piattaforma utile: 5000 mm
Lunghezza utile con barriere di centraggio autovettura: 5300 mm
Corsa: 2400 mm (variabile in base all'interpiano e pavimentazione)
Utile interpiano: 2100 mm

Le misure e portate possono essere modificate in base all'esigenza del cliente.

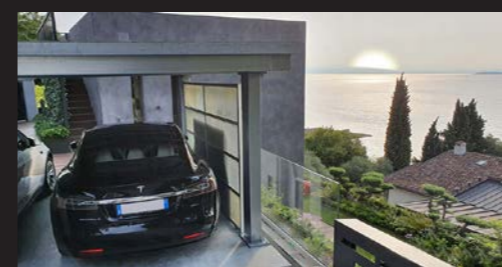
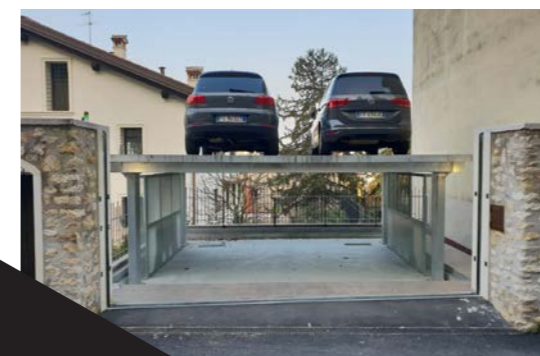

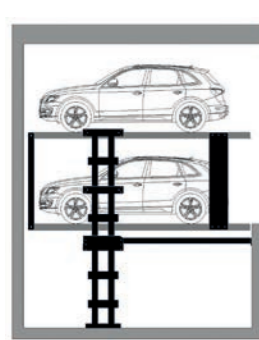

BOX H2

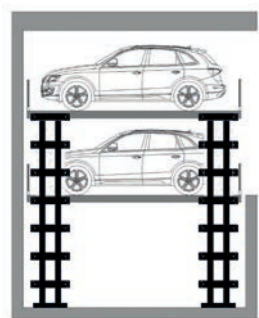

BOX H4

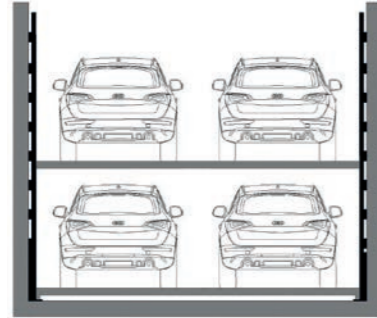

Box H2-H4

Parcheggio **multiplo** per auto a posti indipendenti con sistema **a colonna**

Parcheggio meccanizzato per 2 o 4 auto



Sistema
Colonna



Portata
2500/3000 kg
per auto



Motore
Kw 5,5/7,5
Volt 380
(220 con
inverter)

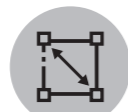

**Altezza fossa
totale**
2300 mm
con interpiano
da 2000 mm



Conformità
2006/42/CE
2014/30/UE
2014/35/UE

Dimensioni consigliate

Larghezza fossa:
3000 mm (H2) / 5600 mm (H4)
Lunghezza fossa: 5600 mm
Larghezza piattaforma utile:
2600 mm (H2) / 5100 mm (H4)
Lunghezza utile con barriere di
centraggio autovettura: 5400 mm
Utile Interpiano: variabile
in base alla fossa

Le misure e portate possono essere modificate in base all'esigenza del cliente.

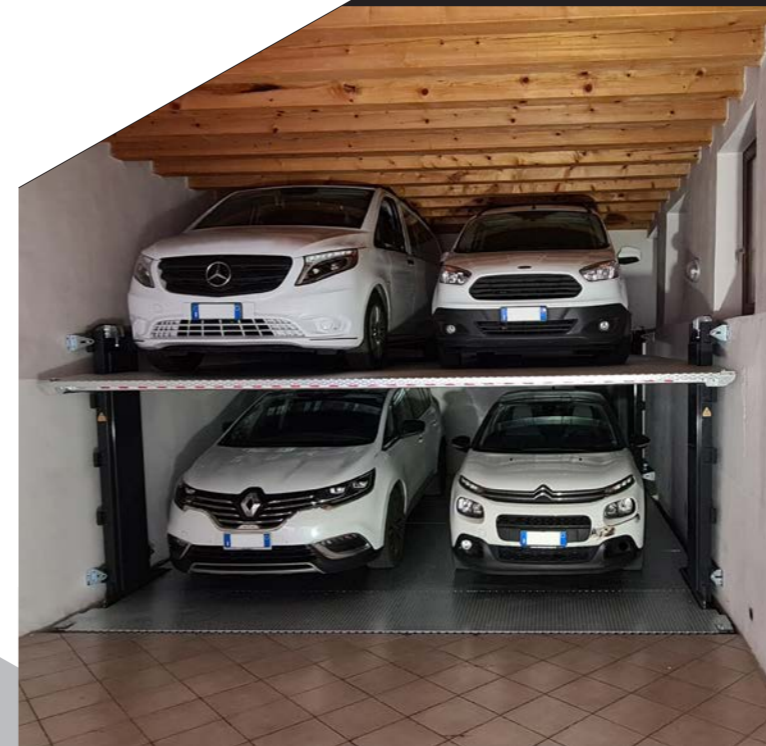

SOLUZIONE
VERSATILE
ED EFFICIENTE.
PROGETTATA
PER SFRUTTARE AL
MASSIMO LO SPAZIO
A DISPOSIZIONE.

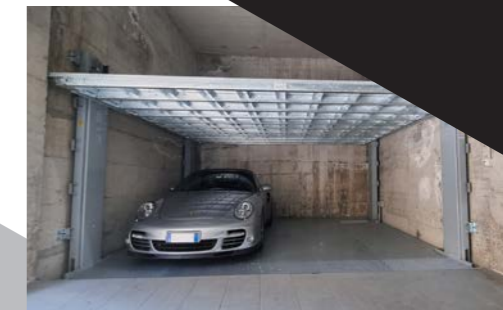

3

Montacarichi



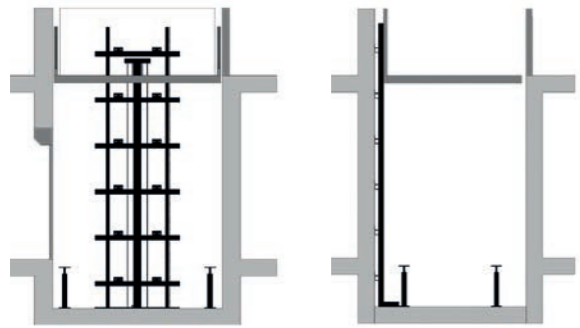
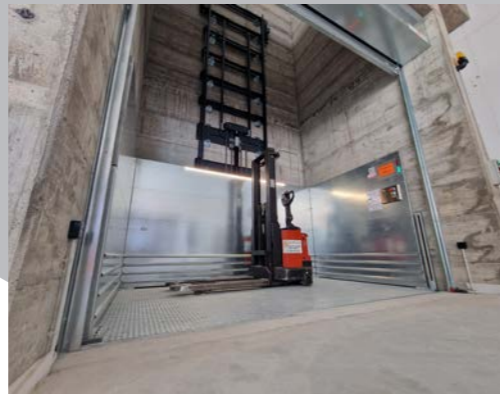
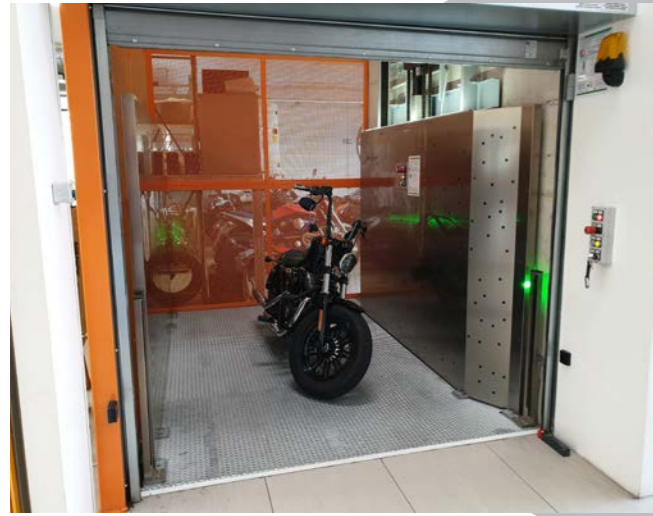

Work H1

Montacarichi a **singola colonna**

Portata a richiesta con o senza persona a bordo



Sistema
A 1 colonna



Corsa
Da 0 a 12000 mm



Portata
a richiesta



Motore
Kw 3/4

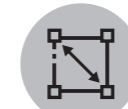

Fossa minima consigliata
500 mm



Conformità
2006/42/CE
2014/30/UE
2014/35/UE

Le misure e portate possono essere modificate in base all'esigenza del cliente.

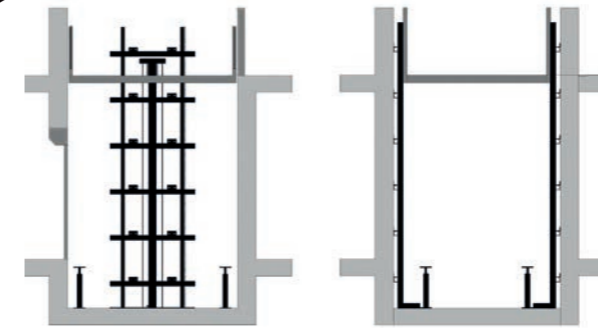

Work H2

Montacarichi a **doppia colonna**

Portata a richiesta con o senza persona a bordo



Sistema
Colonna



Corsa
Da 0 a 12000 mm



Portata
a richiesta



Motore
Kw 4/5,5/7,5
(in base alla portata)



Fossa minima
300 mm



Conformità
2006/42/CE
2014/30/UE
2014/35/UE



Cabina in acciaio inox

Le misure e portate possono essere modificate in base all'esigenza del cliente.

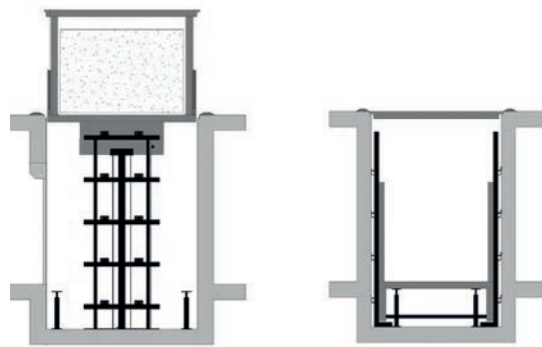
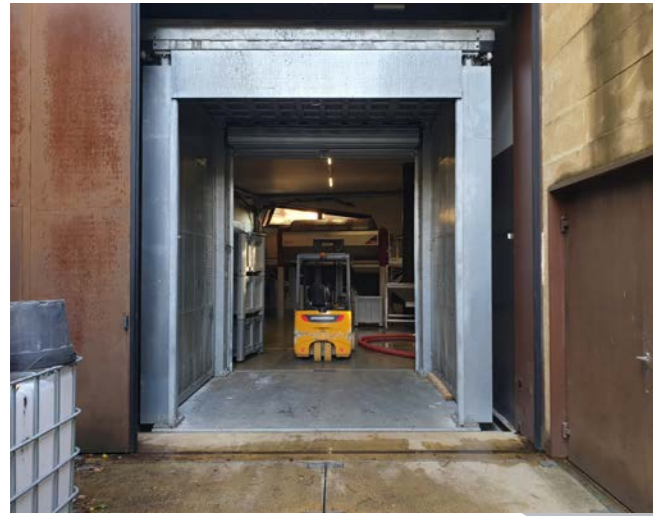

Work H2 T

Montacarichi a **doppia colonna** con **tezzo di copertura**

Portata a richiesta con o senza persona a bordo



Sistema
Colonna



Corsa
Da 0 a 12000
mm



Portata
a richiesta



Motore
Kw in base
alla portata
Volt 380 (220
con inverter)

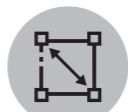

**Fossa
minima**
800 mm



Conformità
2006/42/CE
2014/30/UE
2014/35/UE

Le misure e portate possono essere modificate in base all'esigenza del cliente.

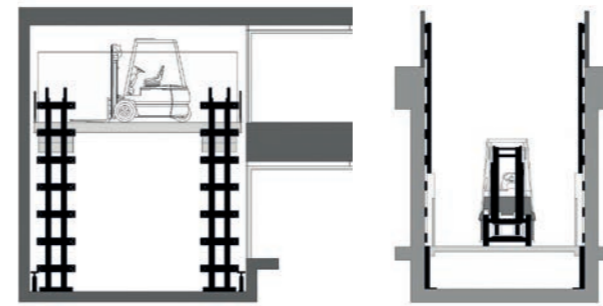

Work H4

Montacarichi a **quattro colonne**

Portata a richiesta con o senza persona a bordo



Sistema
Colonna



Corsa
Da 0 a 12000
mm



Portata
a richiesta



Motore
Kw 5,5/7,5/9
(in base alla
portata)

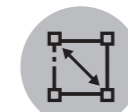

**Fossa
minima**
300 mm



Conformità
2006/42/CE
2014/30/UE
2014/35/UE

Le misure e portate possono essere modificate in base all'esigenza del cliente.

4

Elevatori
per box

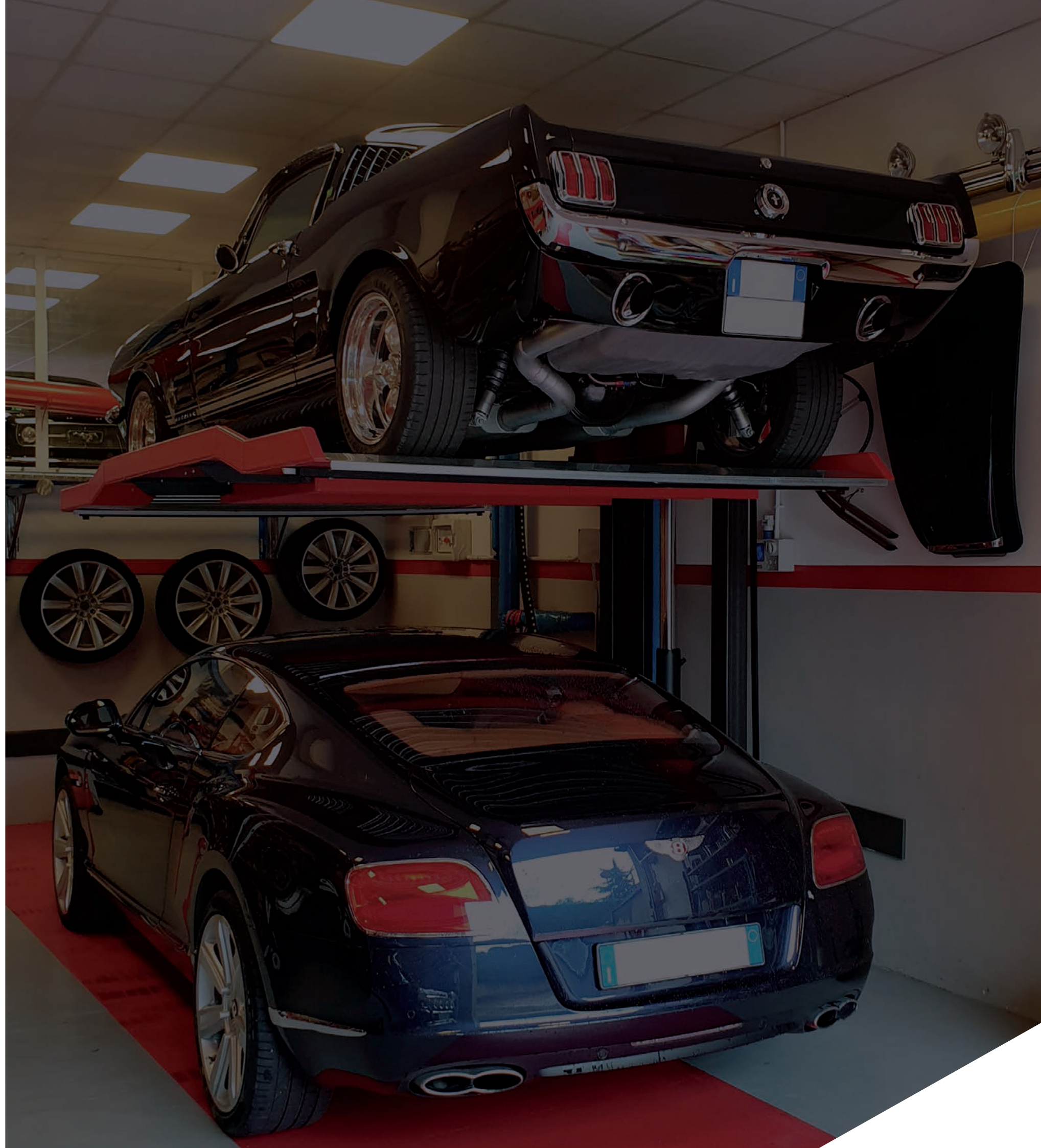

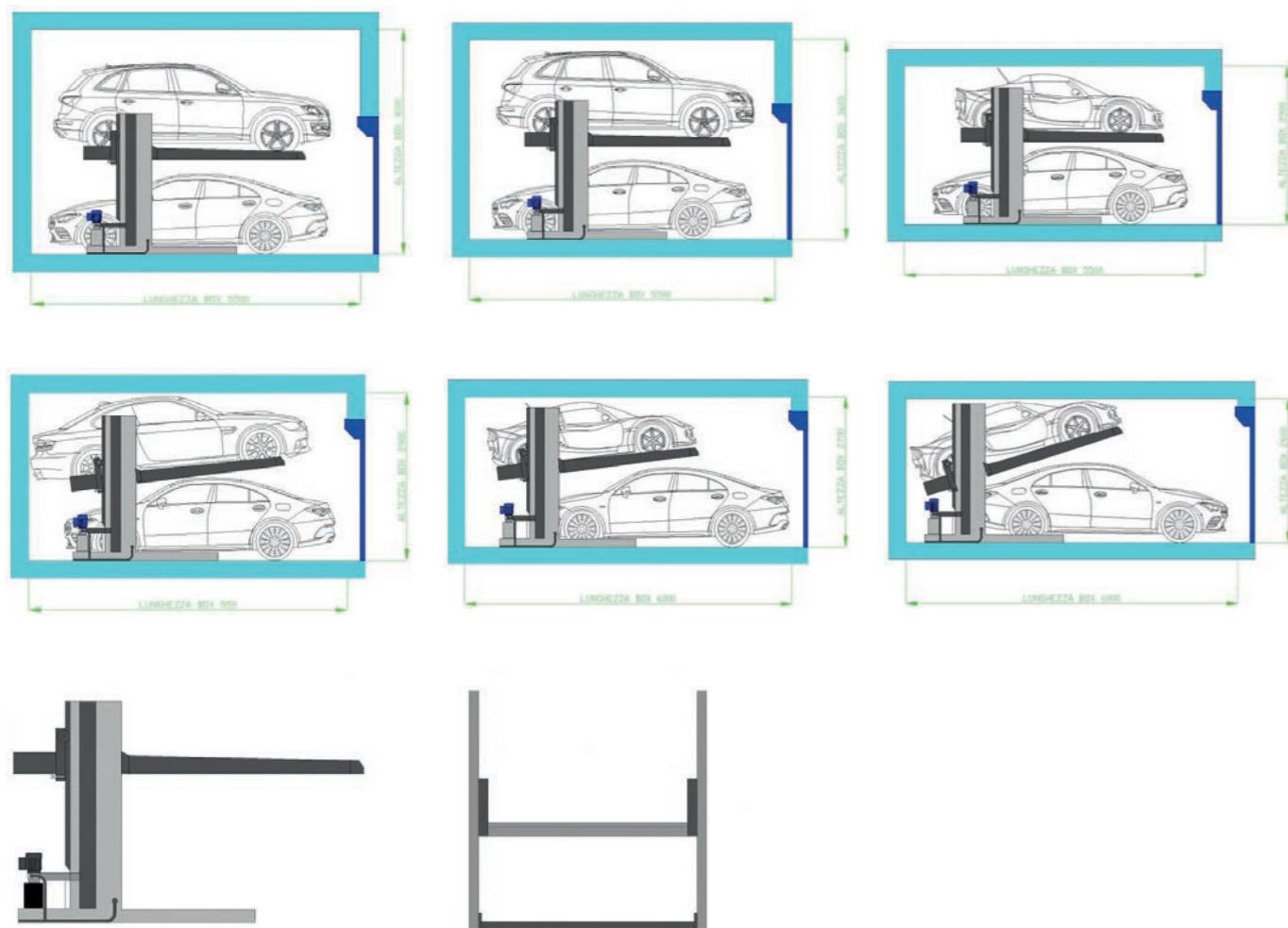

IMPIANTO FLESSIBILE ED AFFIDABILE PER CREARE NUOVI POSTI AUTO NEL MINIMO SPAZIO DISPONIBILE.

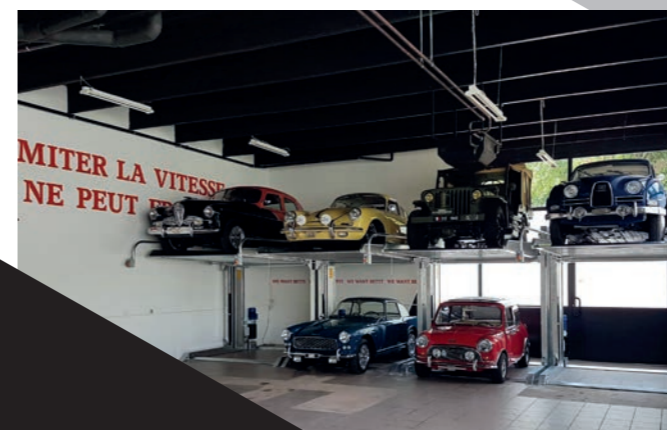

B-Box

Raddoppiatore posto auto con sistema a colonna

3 modelli disponibili: S, L, XL.



Sistema
Colonna



Portata
2500/3000
kg



Motore
Kw 1,5
Volt 220



Conformità
2006/42/CE
2014/30/UE
2014/35/UE

Dimensioni consigliate

Lunghezza piattaforma: 3700 mm
Lunghezza piede: 2500 mm
Altezza colonna: 2500 mm
Utile pianale:
1900 mm (S) / 2100 mm (L) / 2300 mm (XL)
Utile fra le due colonne:
2100 mm (S) / 2300 mm (L) / 2500 mm (XL)
Larghezza totale:
2300 mm (S) / 2500 mm (L) / 2700 mm (XL)
Altezza massima: 1950 mm regolabile e inclinabile

Le misure e portate possono essere modificate in base all'esigenza del cliente.

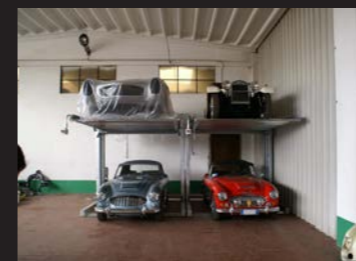

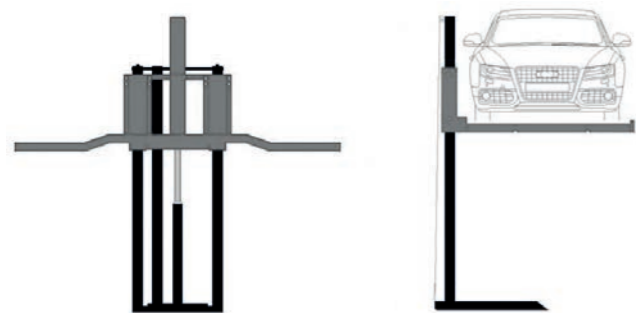

H-Box

Raddoppiatore posto auto con sistema a doppia colonna

4 modelli disponibili: S, L, XL, XXL



Sistema
Colonna



Portata
2000 kg



Motore
Kw 1,5
Volt 220



Conformità
2006/42/CE
2014/30/UE
2014/35/UE

Dimensioni consigliate

Lunghezza piattaforma: 3500 mm
Larghezza utile pianale:
1850 (S) / 1900 (L) / 1950 (XL) / 2000 mm (XXL)
Altezza colonna: 3500 mm
Larghezza colonna: 1290 mm
Larghezza totale:
2320 (S) / 2370 (L) / 2420 (XL) / 2470 mm (XXL)
Altezza utile: 1950 mm

Le misure e portate possono essere modificate in base all'esigenza del cliente.



MOLTIPLICARE I VOSTRI SPAZI CON UNA SOLUZIONE DI PARCHEGGIO SICURA E VERSATILE, COMPLETAMENTE PERSONALIZZABILE.



5

Piattaforme



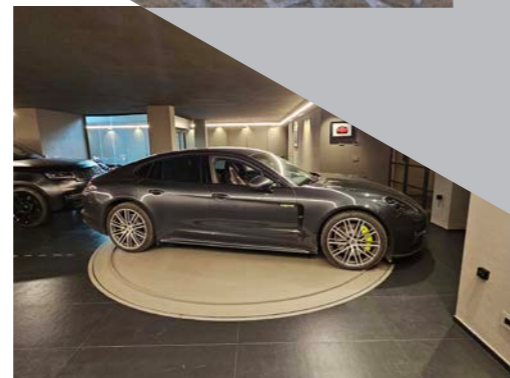

Piattaforma rotante

Facilità di manovra e ottimizzazione degli spazi limitati



Portata
3500 kg
o su richiesta



Diametro piattaforma standard
3975 / 4275 / 4975 mm
o su misura



Altezza
350 mm (con pavimento)
300 mm (senza
pavimento)



Conformità
2006/42/CE
2014/30/UE
2014/35/UE

Le misure e portate possono essere modificate in base all'esigenza del cliente.



Piattaforma a trazione

Facilità di parcheggio in spazi minimi



Portata
2500 kg

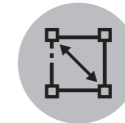

Altezza
Piattaforma:
160 mm
Salita macchina:
75 mm



Motore
Kw 0,25
con inverter
Volt 220



Conformità
2006/42/CE
2014/30/UE
2014/35/UE

Le misure e portate possono essere modificate in base all'esigenza del cliente.

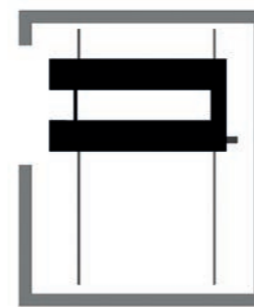
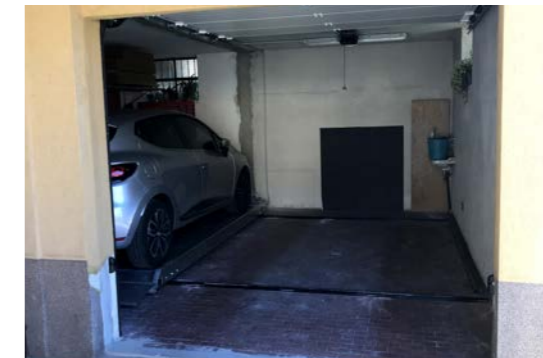

Piattaforma traslante

Più posti auto grazie allo spostamento laterale



Portata
2500 kg



Altezza
Piattaforma:
150 mm



Motore
Kw 1
Volt 220



Conformità
2006/42/CE
2014/30/UE
2014/35/UE

Le misure e portate possono essere modificate in base all'esigenza del cliente.

6

Accessori di chiusura e protezione



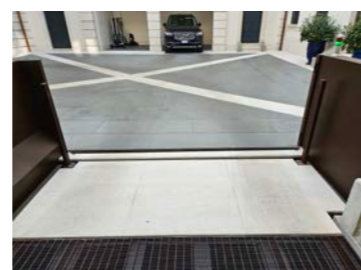

TIPI DI RIVESTIMENTO

Rivestimento in gres

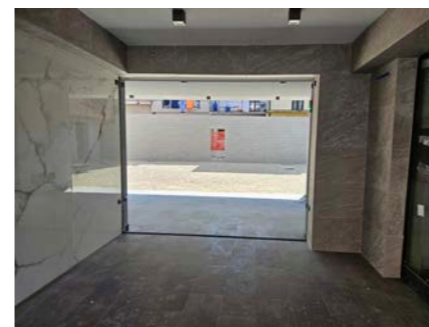

Rivestimento in acciaio inox



Rete microforata in acciaio inox satinato



Rivestimento in legno

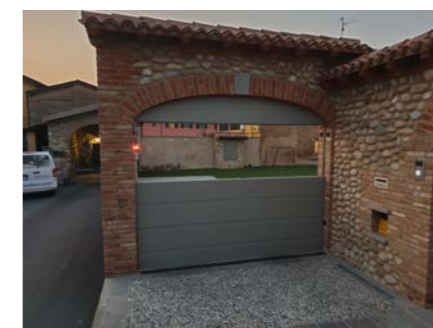
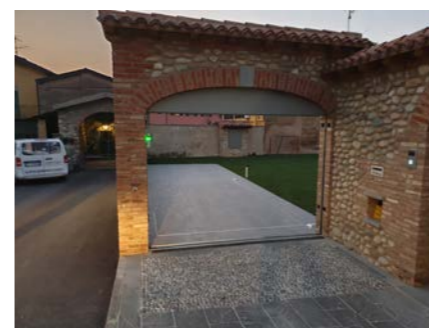

Rivestimento in rame e plexiglass



Cancelli a scomparsa

Diversi tipi di rivestimento e dimensioni



Struttura
Acciaio
zincato a
caldo



Verniciatura
RAL a scelta



Motore
Volt 380
(220 con
inverter)





Legno serigrafato personalizzato



Porte sezionali

Con accessori personalizzati



Serrande avvolgibili e tapparelle

Con accessori personalizzati

Servizi

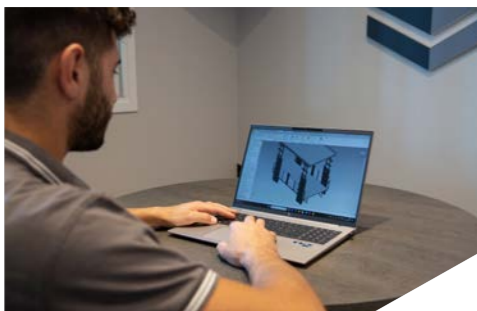

Progettazione

Un filo diretto costantemente aperto con i nostri clienti, fin dalla fase di progettazione. Dialoghiamo con architetti, studi di progettazione, designer, ascensoristi e privati, per trovare le soluzioni ideali per realizzare un impianto su misura, in grado di integrarsi perfettamente con il contesto e l'architettura circostante.

Installazione

Il nostro team di tecnici specializzati si occupa personalmente dell'installazione dei prodotti Fimac Lift, con la massima professionalità e rapidità. Un lavoro di precisione, svolto con cura e attenzione, dalla posa della piattaforma, alle porte ed a tutti i componenti elettrici.



Vendita

Fimac Lift vi accompagnerà nella scelta dei sistemi di parcheggio migliori per organizzare efficacemente i vostri spazi. Dal facilitare l'accesso al garage alla necessità di moltiplicare le opzioni di parcheggio, siamo in grado di offrirvi le soluzioni più innovative per rispondere alle vostre esigenze.

Manutenzione

Concordiamo con il cliente le manutenzioni periodiche post vendita e prevediamo anche una serie di interventi straordinari, per garantire il funzionamento ottimale dei nostri impianti e assicurare prestazioni efficaci e durature nel tempo.



Assistenza

Offriamo un servizio di assistenza tempestivo ed efficace, sia in Italia che all'estero, grazie ad un team di tecnici esperti e competenti. La nostra esperienza sul campo e l'elevato livello tecnologico delle attrezzature, ci permette di intervenire rapidamente a supporto di qualsiasi richiesta.



*"LA SOLUZIONE DI PARCHEGGIO FUNZIONALE
ED ESTETICA, SU MISURA PER TE"*



FIMAC LIFT S.r.l.

Via Montessori 16 - 25013 Carpenedolo (BS)

Tel.: +39 030 13885958 - Mobile: +39 338 8384883

info@fimaclift.com - fimaclift.com

P. IVA e C.F.: 04432320986